

Description

Capillary type T-labeled 80°C, breaking capacity 16A/230V

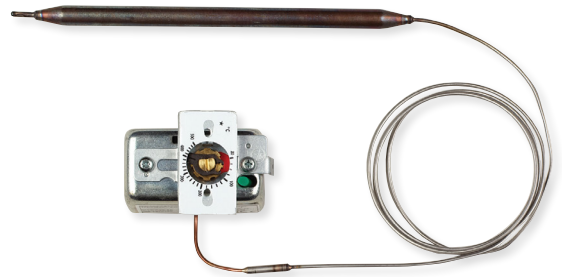

Technical specification

Contact function	Reset	Break temp.	Bulb diameter D	Bulb length L	Capillary length K	Item number
Switching 1-pole	Manual	0-200°C	6 mm	92 mm	1150 mm	1160 156 302
Switching 1-pole	Manual	20-500°C	8 mm	150 mm	1000 mm	1160 156 304

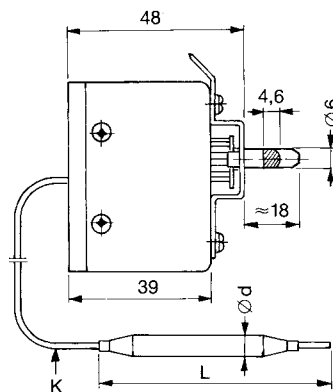
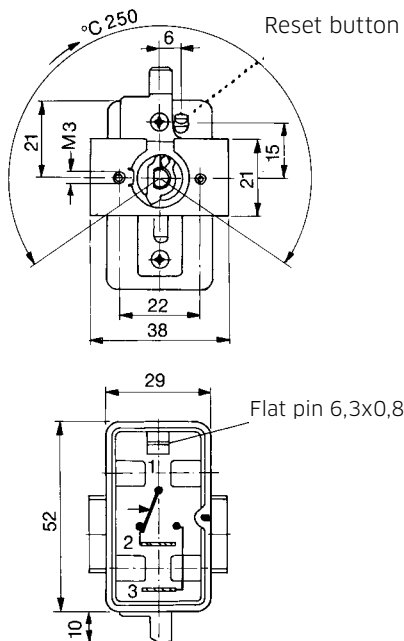

Wiring diagram

